

- F Notice de montage
- GB Installation instructions
- E Manual de instalación
- I Istruzioni di montaggio
- NL Montage-instructies
- D Montageanleitung

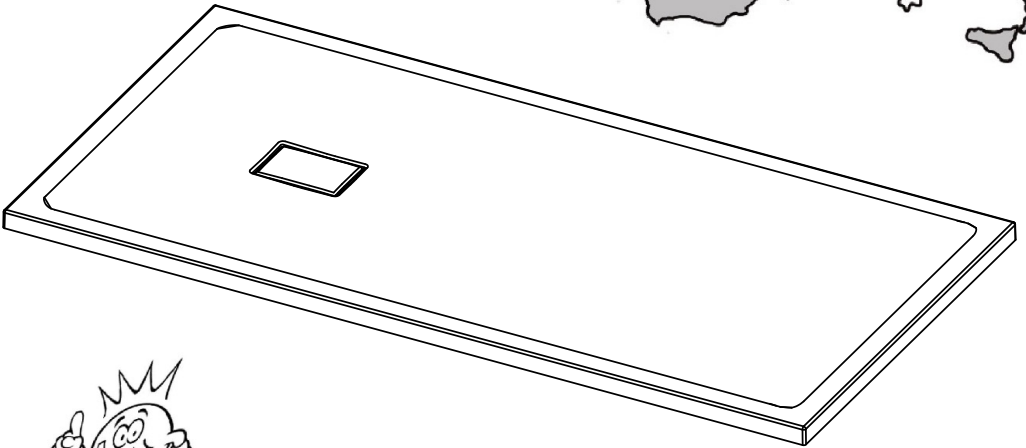

● **F** IMPORTANT

Nettoyez à l'eau savonneuse avant application
d'un cordon de silicone

● **GB** IMPORTANT

Clean with soapy water and soap before
applying a silicone bead

● **E** IMPORTANTE

Limpiar con agua y jabón antes de aplicar un
cordón de silicona

● **I** IMPORTANTE

Pulire con acqua saponata prima di passare il
cordone di silicone

● **NL** BELANGRIJK

Voordat een siliconenlaagje wordt aangebracht,
eerst reinigen met zeepsop

● **D** WICHTIG

Vor dem Auftragen von Silikon mit Seifenwasser
reinigen

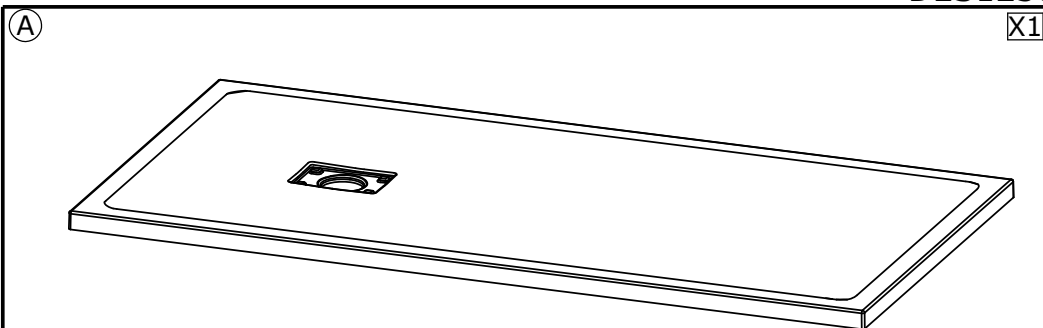
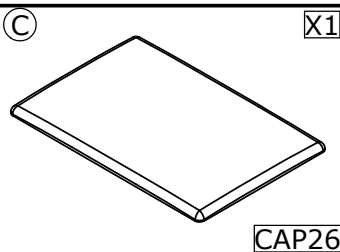
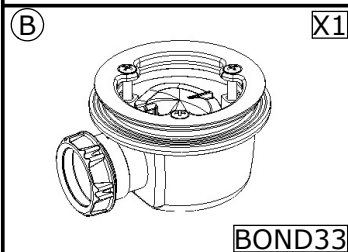
80x80 REC63790x90 REC585100x80 REC587120x80 REC589140x80 REC592160x80 REC595180x80 REC598100x90 REC588120x90 REC590140x90 REC593160x90 REC596180x90 REC599100x100 REC586120x100 REC591140x100 REC594160x100 REC597180x100 REC600

- Les quantités données sont les quantités utiles au montage. les sachets fournis contiennent des pièces supplémentaires.
- De aangegeven aantallen zijn vereist voor de montage. De verpakking bevat extra onderdelen.
- Die Mengenangaben beziehen sich auf die für die Montage nötigen Teile. Eventuell weitere beige-packte Teile ignorieren.
- Las cantidades indicadas son las cantidades necesarias para el montaje. Las bolsitas incluidas contienen piezas suplementarias.
- Le quantità fornite sono le quantità necessarie al montaggio. I sacchetti forniti contengono pezzi supplementari.

- Matériel nécessaire
- Benodigdheden
- Erforderliche Werkzeuge
- Material necesario
- Materiale necessario

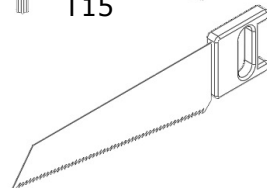

- Ou
- Of
- Oder
- O
- O

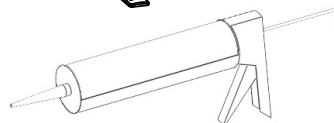
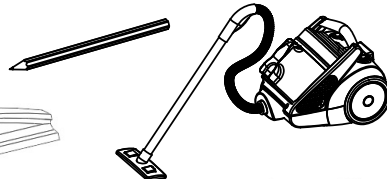
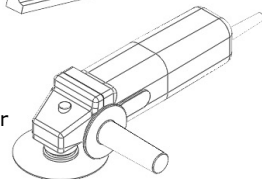
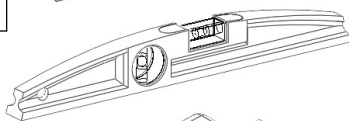
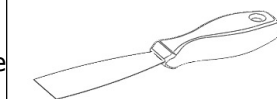

- Colle polyuréthane ou MS polymère
- Polyurethaan of MS-polymeer lijm
- Polyurethan-Klebstoff oder MS-Polymer
- Pegamento poliuretano o polímero MS
- Colla poliuretanică o MS polimer



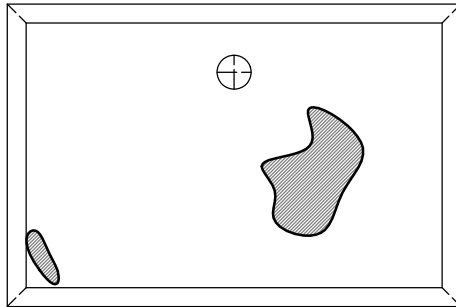

Ⓢ D'éventuelles irrégularités de surface sur le dessous de votre receveur n'empêchent pas une installation conforme aux préconisations de pose. La colle (type polyuréthane ou MS polymère) comblera facilement ces manques lors du collage.

Ⓢ Any surface irregularities on the underside of the shower tray have no influence on the installation according to the installation recommendations. The adhesive (polyurethane or MS polymer) compensates for these unevenness when bonding the feet off without any problems.

Ⓢ Posibles irregularidades de la superficie en la parte inferior del receptor no impida la instalación de acuerdo con las recomendaciones de instalación. El adhesivo (tipo poliuretano o polímero MS) rellenará fácilmente estos huecos al pegar los pies.

Ⓢ Eventuali irregolarità della superficie nella parte sotto della doccia non impediscono l'installazione in base alle raccomandazioni di montaggio. La colla (tipo poliuretano o MS polimero) riempirà facilmente queste lacuna quando si incollano i piedini.

Ⓢ Eventuele onregelmatigheden in de vlakke onderzijde van uw douchebak vormen geen belemmering voor een installatie conform aan de gestelde richtlijnen. De lijm (type polyurethaan of MS-polymeer) vult eventuele openingen makkelijk op tijdens het lijmen.

Ⓢ Eventuelle Unregelmäßigkeiten der Oberfläche an der Unterseite Ihrer Duschwanne haben keinen Einfluss auf die Installation gemäß den Einbauempfehlungen. Der Klebstoff (Typs Polyurethan oder MS-Polymer) gleicht diese Unebenheiten beim Verkleben problemlos aus.



Ⓢ Aspirer le dessous de votre receveur avant la pose

Ⓢ Vacuum the bottom of the shower tray before installation

Ⓢ Aspirar la parte inferior de su plato de ducha antes de instalarlo

Ⓢ Aspirare la parte sottostante del piatto doccia prima dell'installazione

Ⓢ Stofzuig de bodem van de douchebak voor de installatie

Ⓢ Saugen Sie den Boden der Duschwanne vor der Installation ab



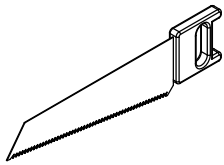

- F Découpe optionnelle du receveur
- GB Optional cutting of the receiver
- E Corte opcional del receptor
- I Taglio opzionale del ricevitore
- NL Optioneel snijden van de ontvanger
- D Optionales Schneiden des Empfängers

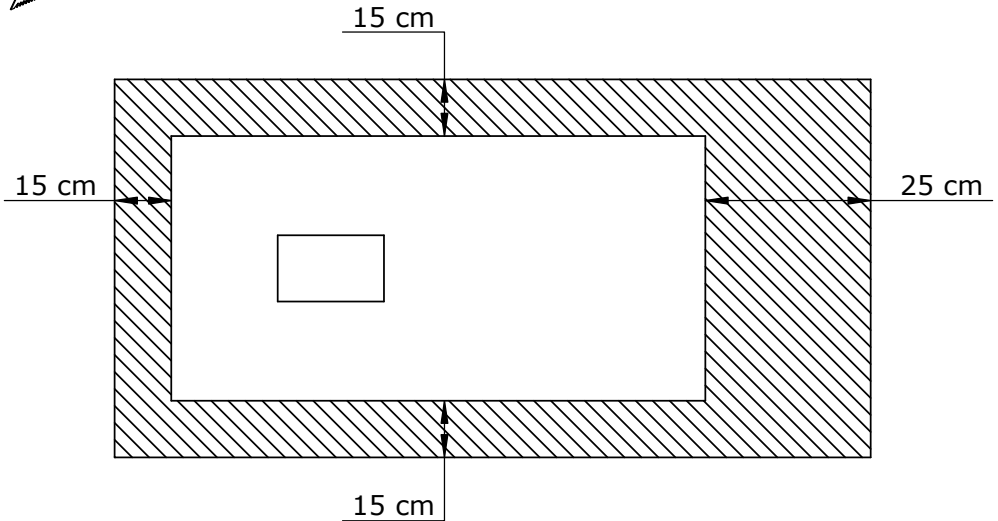

- Zone maxi découpable (Découpe possible sur maximum 3 des 4 côtés du receveur)
- Maxi cuttable area (Cutout possible on a maximum of 3 of the 4 sides of the tray)
- Área de corte maxi (corte posible en un máximo de 3 de los 4 lados de la bandeja)
- Maxi superficie tagliabile (Ritaglio possibile su un massimo di 3 dei 4 lati del vassoio)
- Maximaal snijgebied (maximaal 3 van de 4 zijden van de lade kunnen worden gesneden)
- Maximaler Schneidbereich (Ausschnitt auf maximal 3 der 4 Seiten des Trays möglich)



- Si vous avez découpé votre receveur, vous devez appliquer une couche de colle polyuréthane ou MS polymère à l'aide d'une spatule sur la surface coupée, bien aspirer les poussières résiduelles sur la tranche du receveur avant d'appliquer le mastic/colle.
- If you cut your shower tray you must apply a polyurethan adhesive or MS polymer layer using a spatula over the cut surface.
- Si ha recortado el plato, debe aplicar una capa de pegamento poliuretano o polímero MS en la superficie recortada. Puede ayudarse de una espátula, Aspirar el polvo residual en el lateral del plato antes de aplicar el pegamento.

- Se avete tagliato il vostro piatto, dovete applicare della colla poliuretanic o MS polimero con l'aiuto di una spatola sul lato tagliato, Aspirare accuratamente la polvere residua sul bordo del piatto prima di applicare il sigillante/adesivo.
- Wanneer u uw douchebak heeft bijgesneden dient u met een spatel een laag polyuretaan lijm of MS polymereop de rand het afgesneden deel aan te brengen, verwijder de overgebleven stof- en kunststofdeeltjes op de douchebak voordat de lijm wordt aangebracht.
- Wenn Sie Ihre Duschwanne schneiden müssen Sie ein Polyurethan-Klebstoff-Schicht oder MS-polymere mit einem Spatel über den Schnitt zutreffen Oberfläche, den restlichen Staub vor dem Auftragen des Dichtmittels / Klebers gründlich absaugen.

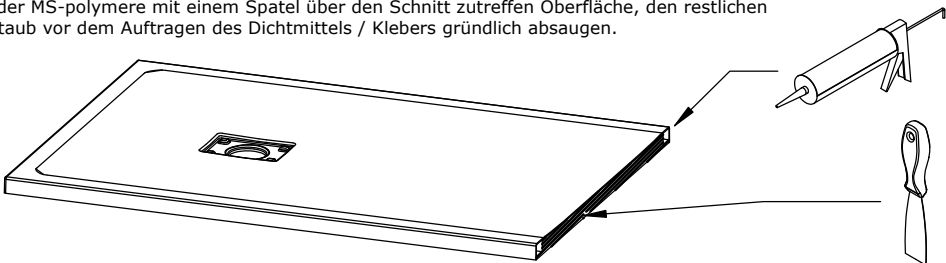

- F** Nombre de pieds **GB** Feet quantity **E** Cantidad de pies
I Quantità di piedin **NL** Hoeveelheid voeten **D** Zahl der FüÙe

80x80	4	90x90	4		
100x80	4	100x90	4	100x100	4
120x80	8	120x90	8	120x100	8
140x80	9	140x90	9	140x100	9
160x80	11	160x90	11	160X100	11
180x80	12	180X90	12	180X100	12

F La distance bord à bord entre deux pieds ne doit pas être de plus de 25 cm.
 LES PIEDS DOIVENT ETRE INSTALLES SUR LES NERVURES DU RECEVEUR.

GB The distance from the edge of the shower tray to the edge of a peripheral support should be no more than 25 cm.
 THE FEET MUST BE INSTALLED ON THE SHOWER TRAY RIBS.

E La distancia enrte cada pie no debe superar los 25 cm.
 LOS PIES DEBEN ESTAR INSTALADOS SIGUIENDO LAS NERVADURAS DEL PLATO.

I Il bordo di distanza dal bordo tra due piedi non dovrebbe essere superiore a 25 cm.
 I PIEDI DEVONO ESSERE ISTALLATI SULLE NERVATURE DEL PIATTO DOCCIA.

NL De afstand tussen twee stelpoten mag niet meer dan 25 cm bedragen.
 DE STELPOTEN DIENEN OP HET STEUNOPPERVLAK VAN DE DOUCHEBAK GEÏNSTALLEERD TE WORDEN.

D Der Abstand zwischen zwei verstellbaren FüÙen darf 25 cm nicht überschreiten.
 DIE FÜÙE MÜSSEN AUF DEN RIPPEN DER DUSCHTASSE MONTIERT WERDEN.



Scan me

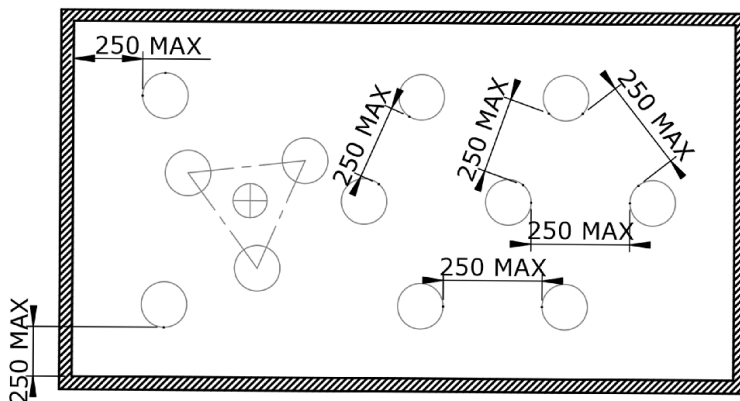

KINESURF TYPE D'INSTALLATIONS POSSIBLES

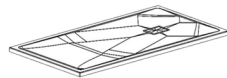

1. Posé sur pieds réglables avec habillage carrelé

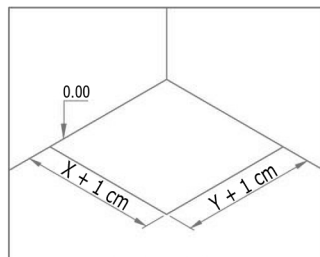
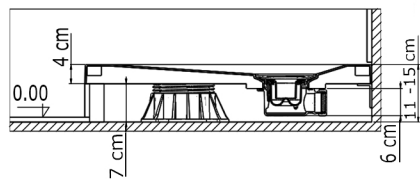
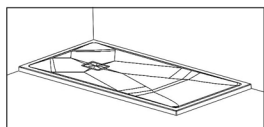

Préparation de l'implantation

2. Posé sur carrelage

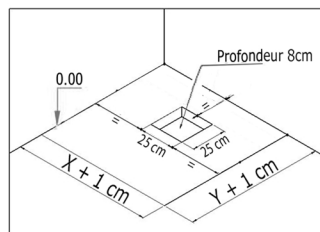
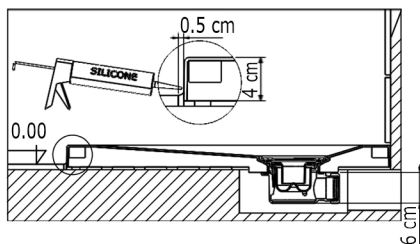
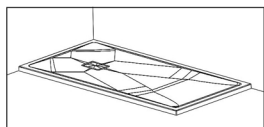

Préparation de l'implantation

3. Encastré et posé sur pieds réglables

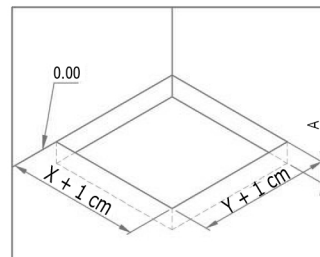
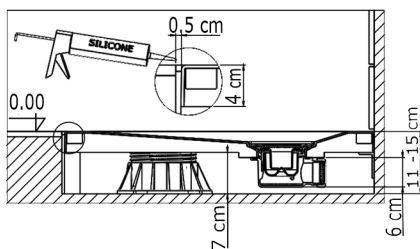
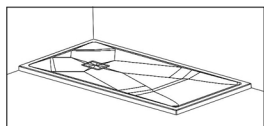

Préparation de l'implantation

4. Encastré et posé sans pieds réglables

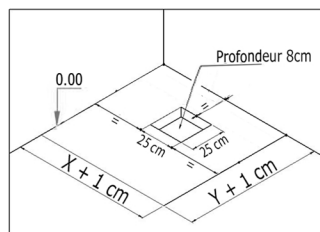
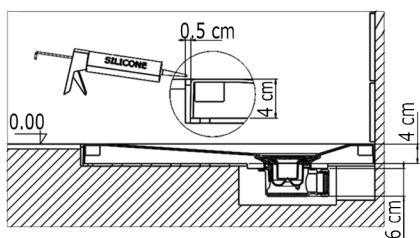
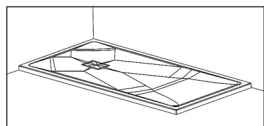

Préparation de l'implantation

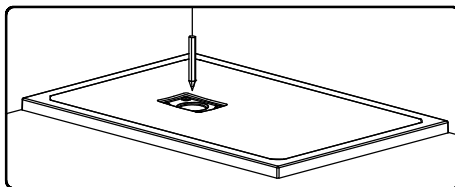

F

Tracer la position de la bonde et réaliser un montage à blanc de la bonde et du receveur

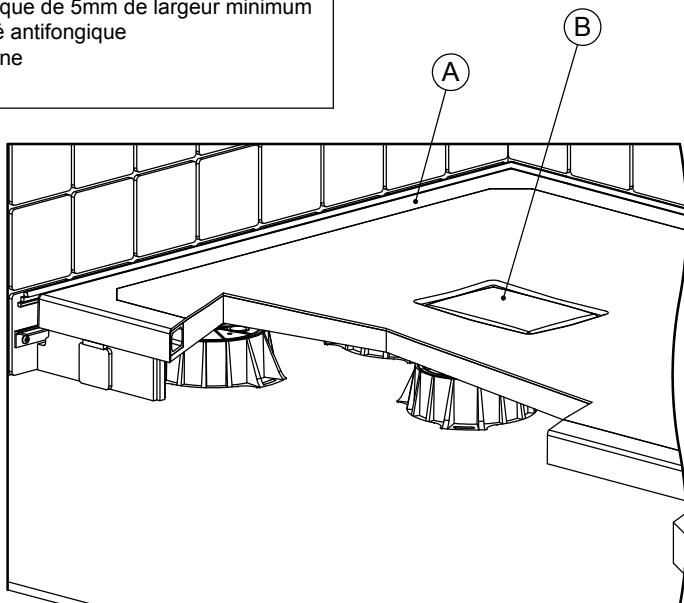
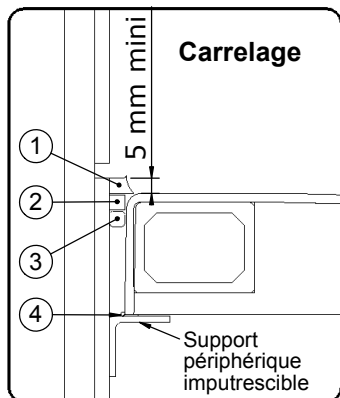
- ① - silicone de finition traité antifongique de 5mm de largeur minimum
- ② - silicone d'étanchéité souple traité antifongique
- ③ - élément de soutien du joint silicone
- ④ - silicone d'appui

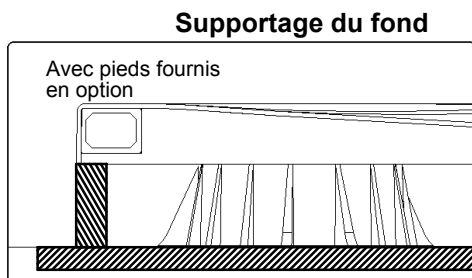
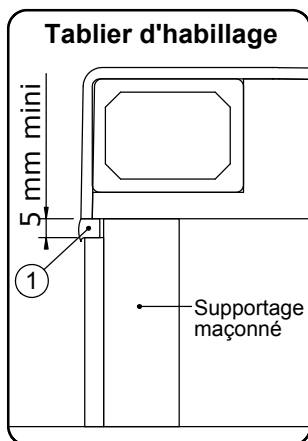
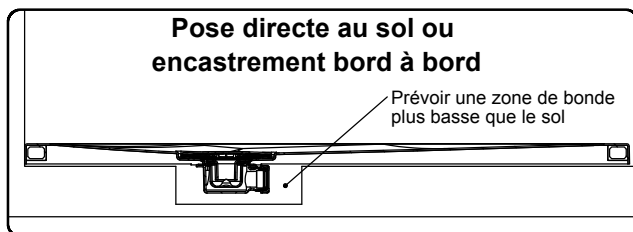

Il est indispensable d'avoir un support imputrescible sur tous les côtés du receveur.





Pendant toute la durée des travaux, protéger le receveur contre toute agression : brûlures, chocs, rayures, décapants...



Le montage d'une *soupape anti-vide* est nécessaire pour une utilisation optimale si un autre appareil sanitaire est raccordé sur la même évacuation.

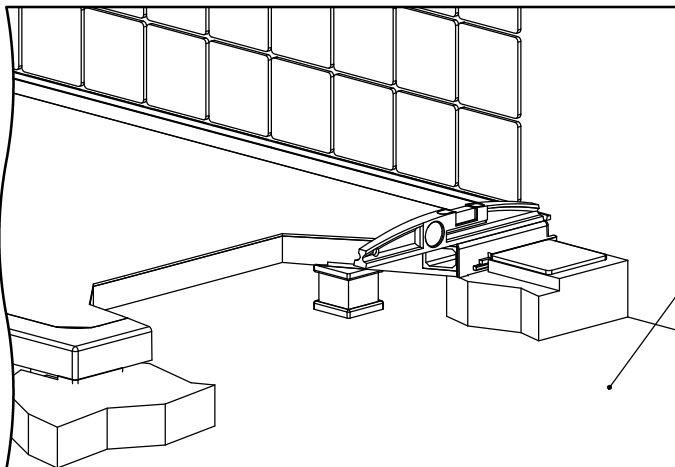

Sol rigide et non humide indispensable.

Ne pas poser sur plancher chauffant.

Pose directe au sol

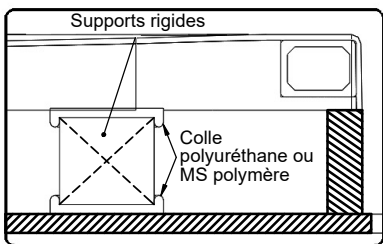
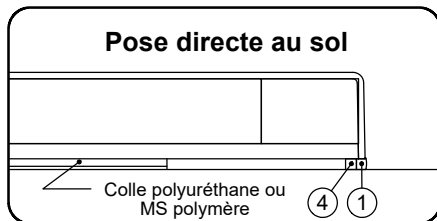

Encastrement bord à bord

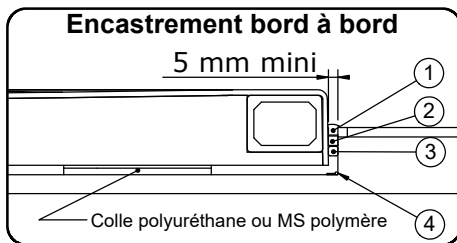

- Ⓕ MISE EN PLACE DES PLOTS DE COLLE POLYURETHANE OU MS POLYMERE
 - Ⓝ LADEN SIE DIE GRUND KLEBER POLYURETHAN ODER MS-POLYMERE
 - Ⓓ BRENG DE POLYURETAAN LIJM OF MS POLYMEERAAN OP DE JUISTE PLAATS
 - Ⓔ COLOCACIÓN DE PLACAS DE PEGAMENTO DE POLIURETANO O MS POLYMER
 - Ⓖ POSIZIONAMENTO PIASTRE DI COLLA POLIURETANO O MS POLIMERO
- Ⓕ Exemple receveur **100x80** Ⓝ voorbeeld met douchebak **100 x 80**
- Ⓓ Beispiel mit Duschwanne **100 x 80** Ⓔ ejemplo de plato de ducha **100 x 80**
- Ⓖ esempio di piatto doccia **100 x 80**

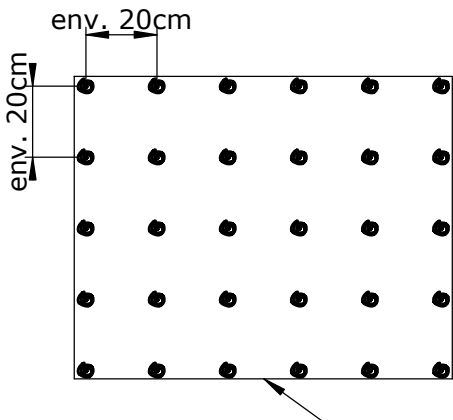

- Ⓕ Colle Polyuréthane ou MS Polymère
- Ⓝ Lijm polyurethaan of MS poltmeer
- Ⓓ Polyurethan-kmebstoff oder MS-polymer
- Ⓔ Pegamento poliuretano o polimero
- Ⓖ Colla poliuretano o MS polimero

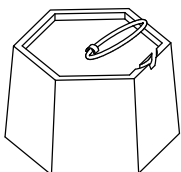
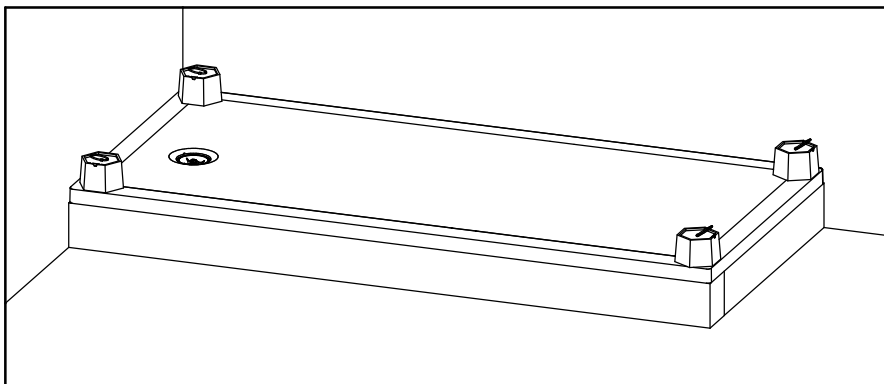

= 15Kg



24H

KINESURF POSSIBLE TYPES OF INSTALLATIONS

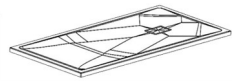

1. Mounted on adjustable legs with tiled cladding

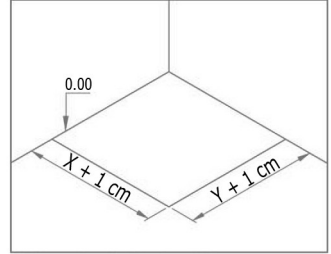
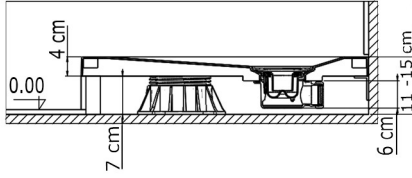
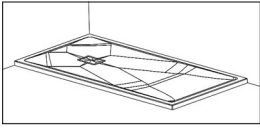

Preparation of the implementation

2. Installed on tiles

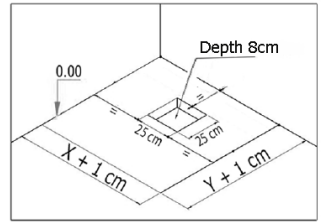
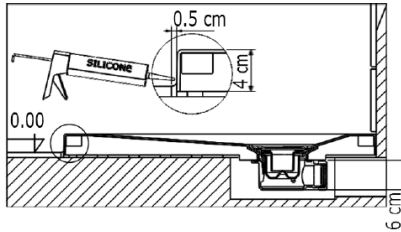
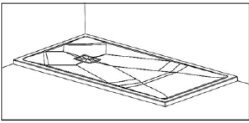

Preparation of the implementation

3. Built-in and placed on adjustable legs

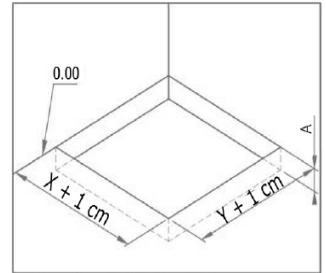
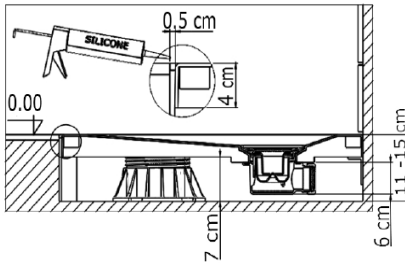
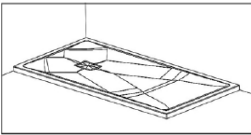

Preparation of the implementation

4. Built-in and installed without adjustable feet

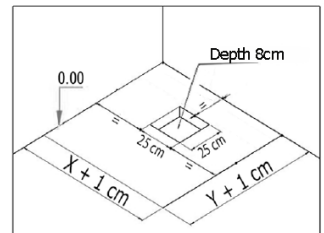
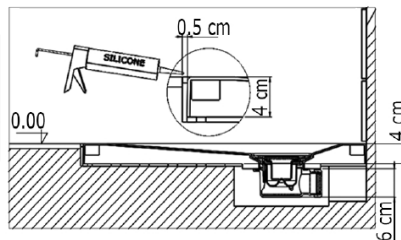
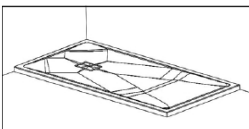

Preparation of the implementation

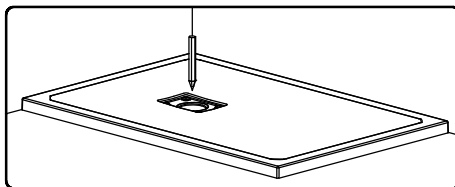

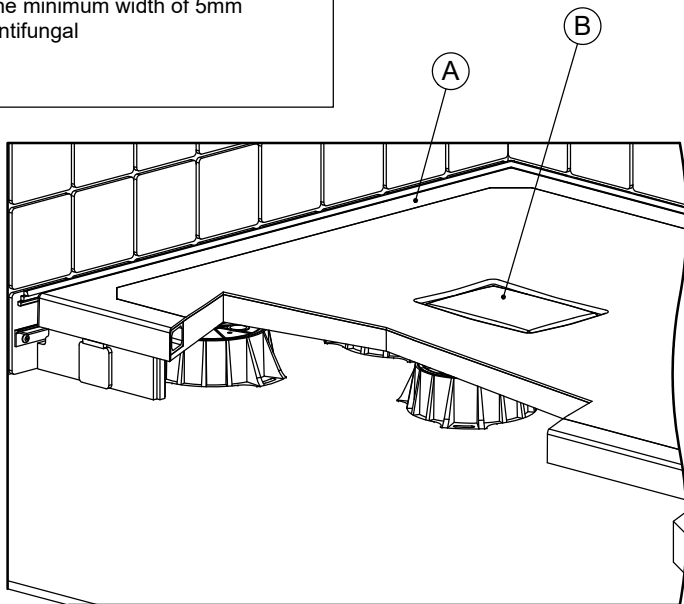
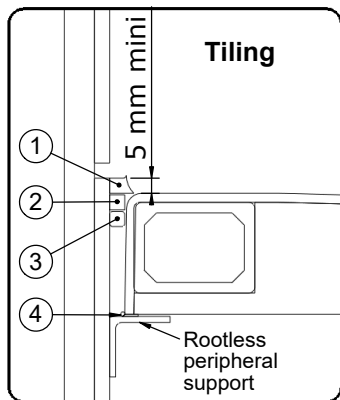

Mark the position of the plug and perform a
White mounting the bung and recipient

- ① - finishing antifungal treated silicone minimum width of 5mm
- ② - flexible sealing silicone treated antifungal
- ③ - support Element silicone seal
- ④ - silicone support

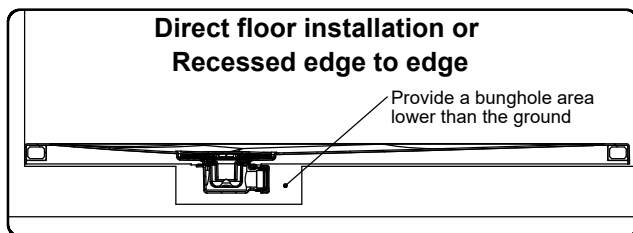
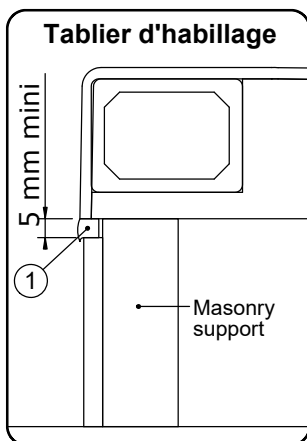

It's essential to
have a rigid support
on all sides of the
shower tray



Supporting the bottom

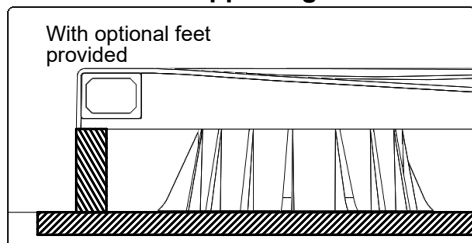



Throughout the duration of the work, protect the recipient against any aggression : burns, shock, scratches, strippers...



The installation of an anti-evacuation valve is necessary for optimum use if another sanitary appliance is connected to the same evacuation

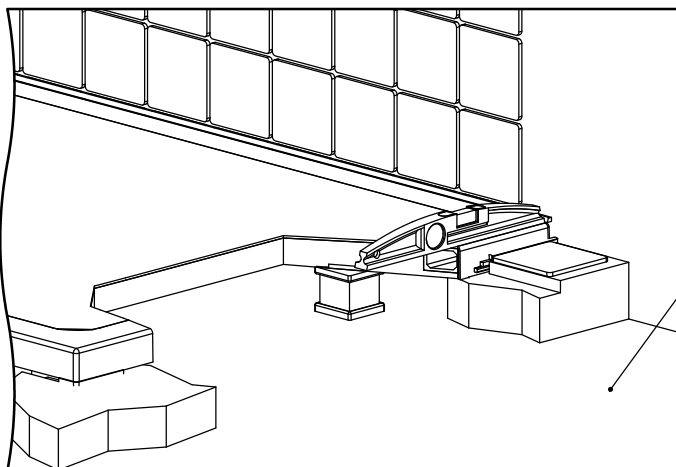

The underlying floor must absolutely be rigid and dry / Ensure a solid dry surface

Do not place on underfloor heating.

Direct floor installation

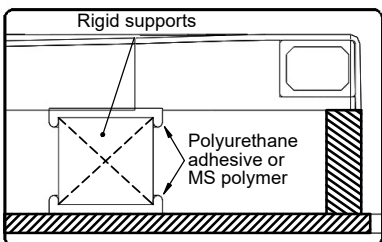
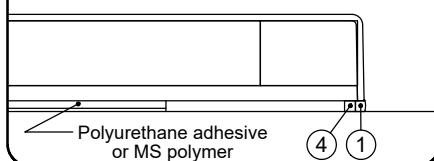

Recessed edge to edge

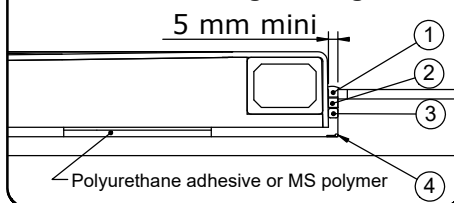

- MISE EN PLACE DES PLOTS DE COLLE POLYURETHANE OU MS POLYMERE
 - LADEN SIE DIE GRUND KLEBER POLYURETHAN ODER MS-POLYMERE
 - BRENG DE POLYURETAAN LIJM OF MS POLYMEERAAN OP DE JUISTE PLAATS
 - COLOCACIÓN DE PLACAS DE PEGAMENTO DE POLIURETANO O MS POLYMER
 - POSIZIONAMENTO PIASTRE DI COLLA POLIURETANO O MS POLIMERO
- Exemple receveur **100x80** ● voorbeeld met douchebak **100 x 80**
- Beispiel mit Duschwanne **100 x 80** ● ejemplo de plato de ducha **100 x 80**
- esempio di piatto doccia **100 x 80**

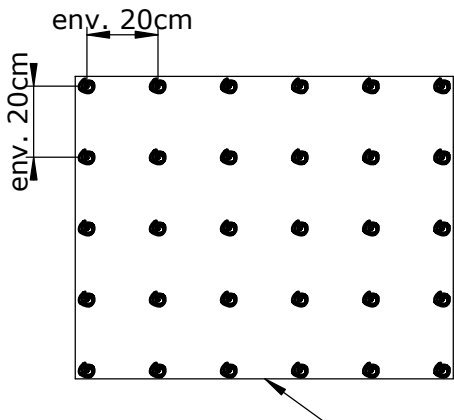

- Colle Polyuréthane ou MS Polymère ● Lijm polyurethaan of MS poltmeer
- Polyurethan-knebstoff oder MS-polymer ● Pegamento poliuretano o polimero
- Colla poliuretano o MS polimero

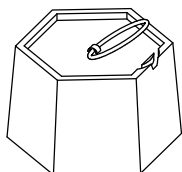
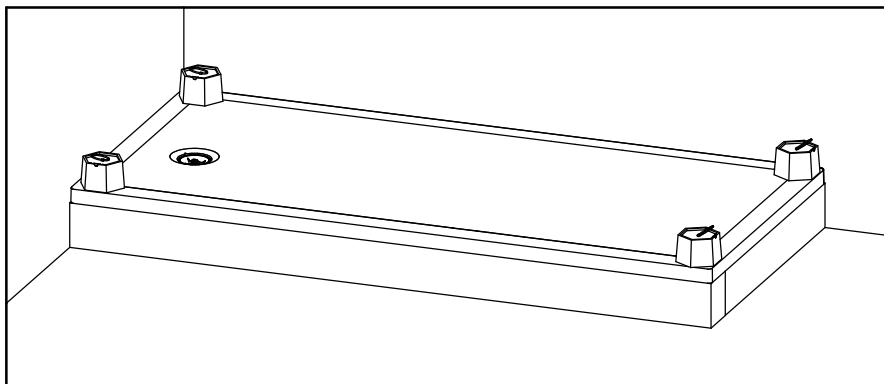

= 15Kg



24H

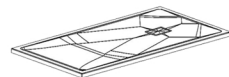

1. Instalación sobre pies regulables con revestimiento de baldosas

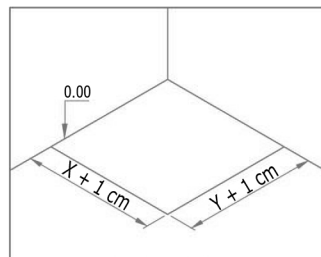
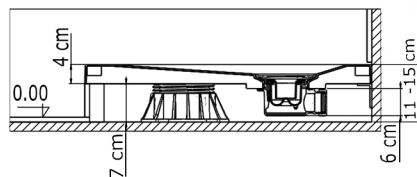
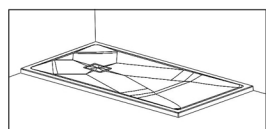

Preinstalación

2. Instalación directa al suelo

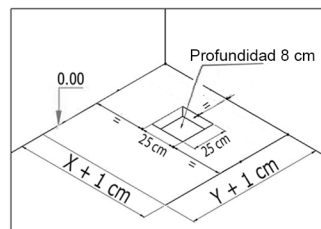
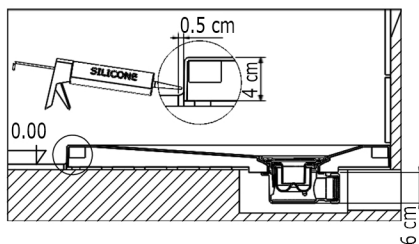
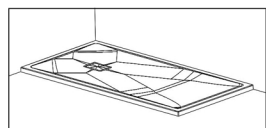

Preinstalación

3. Empotrado e instalado sobre pies regulables

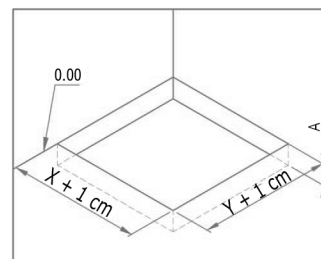
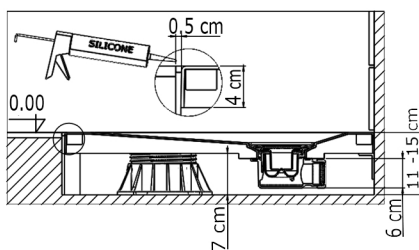
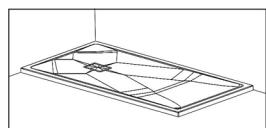

Preinstalación

4. Empotrado e instalado sin pies regulables

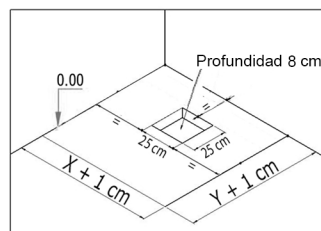
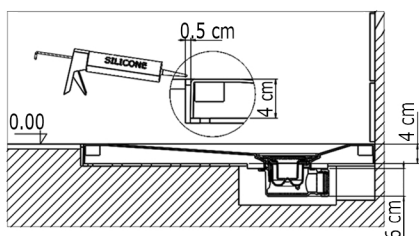
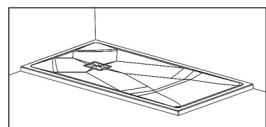

Preinstalación

E

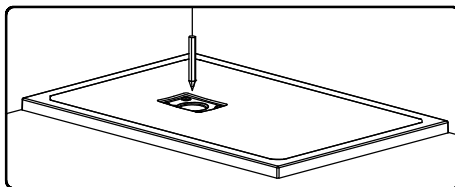

Marcar la ubicación del desagüe y presentar el plato para verificar que esté todo correcto.

- ① - silicona de acabado, antifúngica, 5 mm de anchura mínimo
- ② - silicona de estanqueidad blanda antifúngica
- ③ - elemento de soporte de la junta de silicona
- ④ - silicona de apoyo

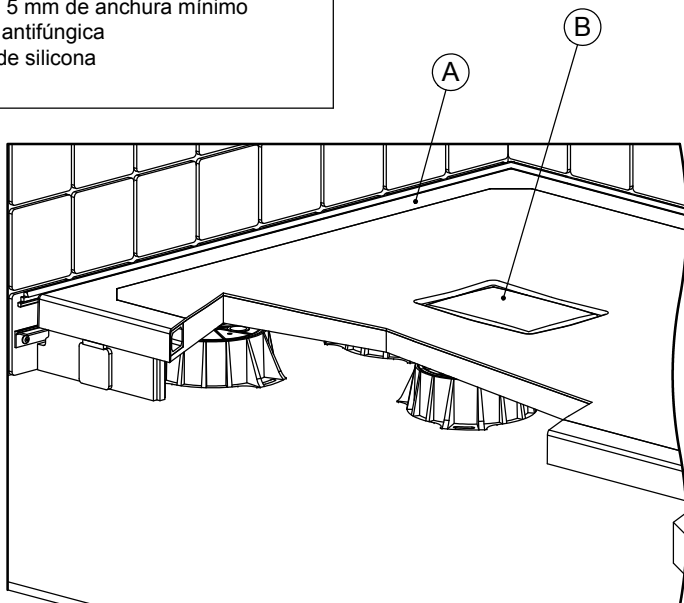
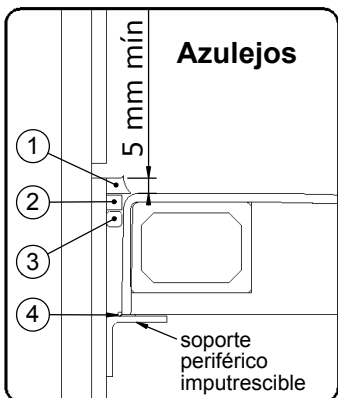

Es imprescindible instalar un soporte imputrescible en todos los lados del plato.

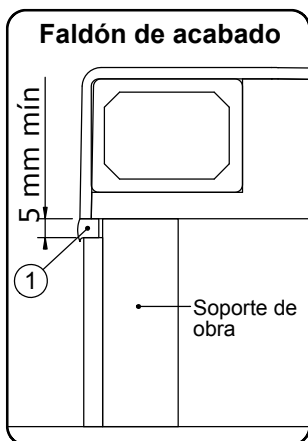
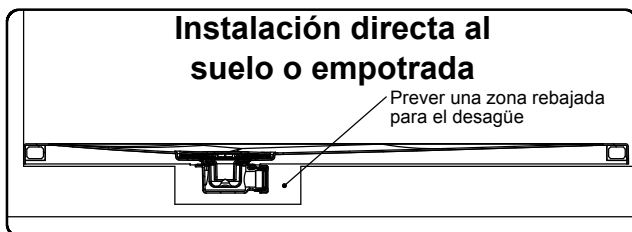

Soportes inferiores

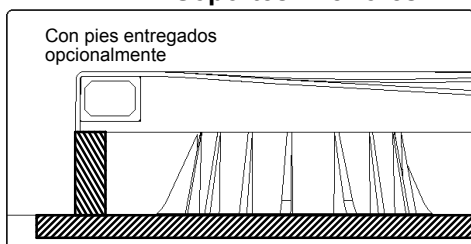



La instalación de una válvula de compensación es necesaria para un uso óptimo, en caso de conectar otro aparato al desagüe del plato.

Durante las obras, proteger el plato de ducha de posibles daños como quemaduras, choques, arañazos...

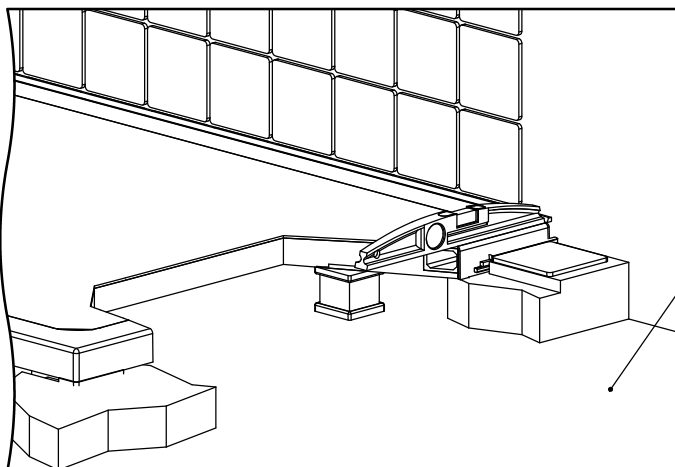

Imprescindible: suelo rígido y sin humedades

Instalación directa al suelo

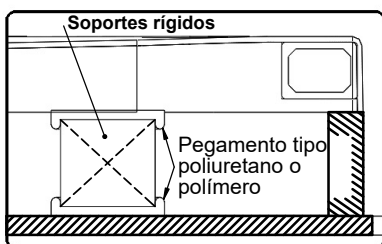
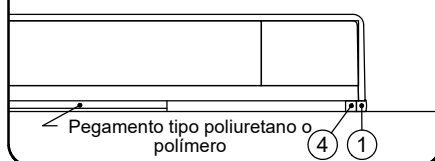

Instalación empotrado en el suelo

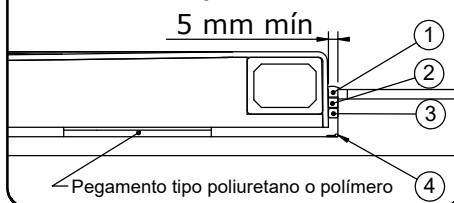

- MISE EN PLACE DES PLOTS DE COLLE POLYURETHANE OU MS POLYMERE
 - LADEN SIE DIE GRUND KLEBER POLYURETHAN ODER MS-POLYMERE
 - BRENG DE POLYURETAAN LIJM OF MS POLYMEERAAN OP DE JUISTE PLAATS
 - COLOCACIÓN DE PLACAS DE PEGAMENTO DE POLIURETANO O MS POLYMER
 - POSIZIONAMENTO PIASTRE DI COLLA POLIURETANO O MS POLIMERO
- Exemple receveur **100x80** ● voorbeeld met douchebak **100 x 80**
- Beispiel mit Duschwanne **100 x 80** ● ejemplo de plato de ducha **100 x 80**
- esempio di piatto doccia **100 x 80**

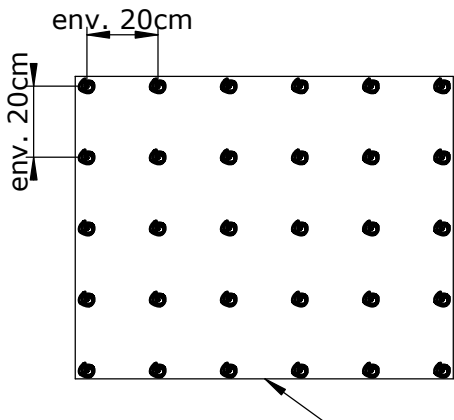

- Colle Polyuréthane ou MS Polymère ● Lijm polyurethaan of MS poltmeer
- Polyurethan-knebstoff oder MS-polymer ● Pegamento poliuretano o polimero
- Colla poliuretano o MS polimero

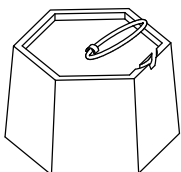
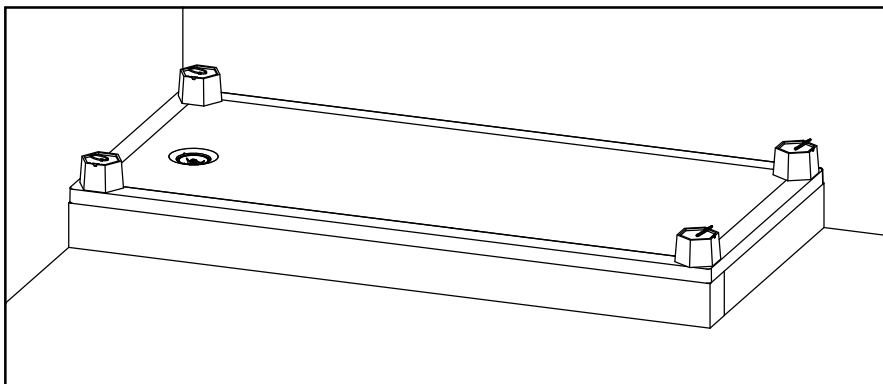

= 15Kg



24H

KINESURF Tipi di installazione possibile

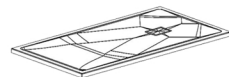

1. Posa su piedi regolabili con rivestimento piastrellato

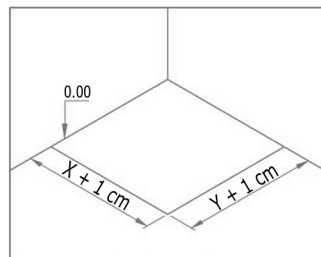
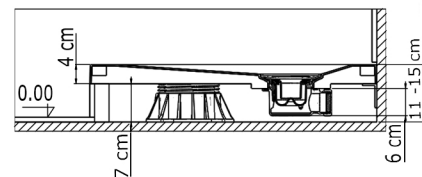
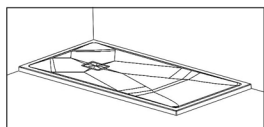

Preparazione impianto

2. Posa su piastrelle

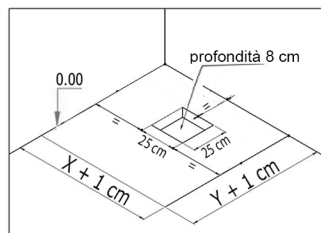
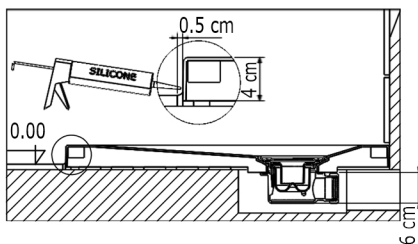
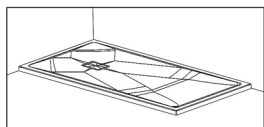

Preparazione impianto

3. Incasso e posa con piedi regolabili

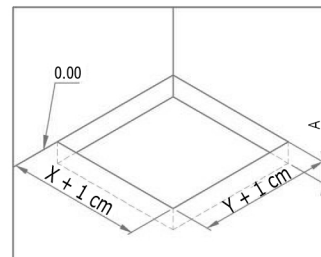
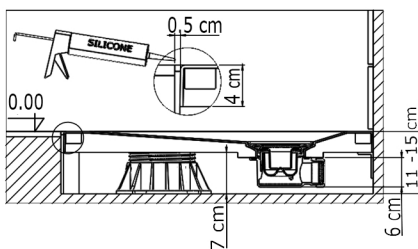
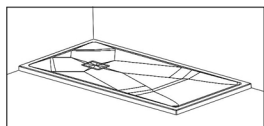

Preparazione impianto

4. Incasso e posa senza piedi regolabili

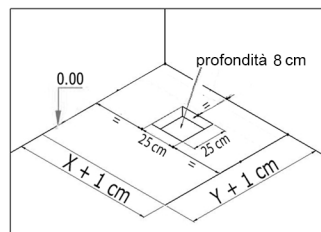
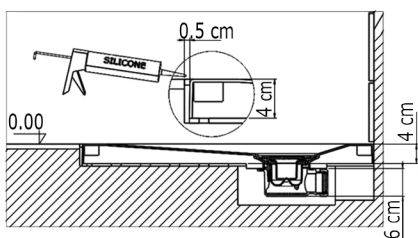
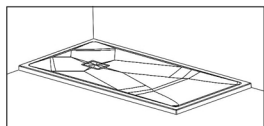

Preparazione impianto

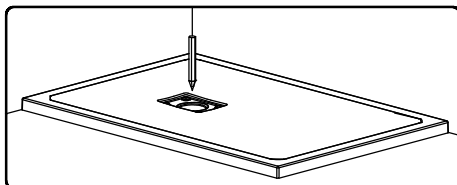

Tracciare la posizione della piletta ed esegui un montaggio a banco della piletta e del piatto

- ① - silicone di finitura antimuffa di larghezza minima di 5mm
- ② - Silicone morbido sigillante antimuffa
- ③ - elemento di supporto silicone
- ④ - supporto di silicone

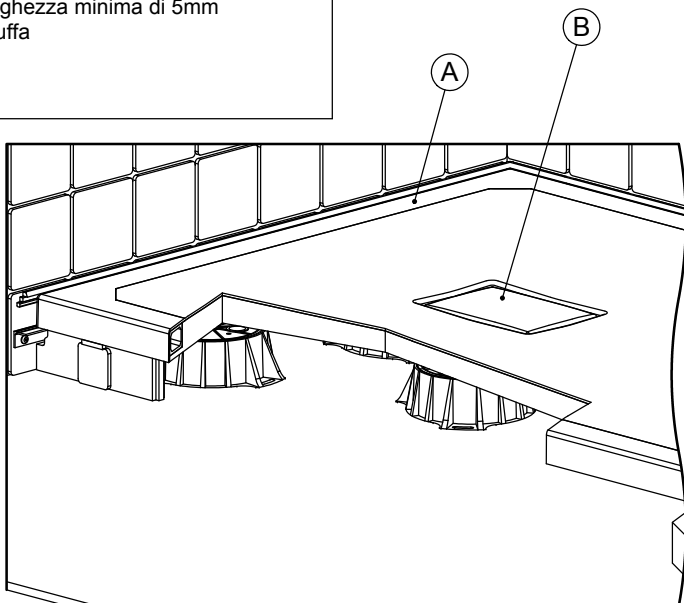
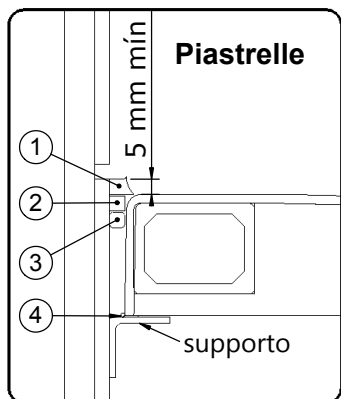

è indispensabile avere un supporto antimuffa su tutti i lati del piatto

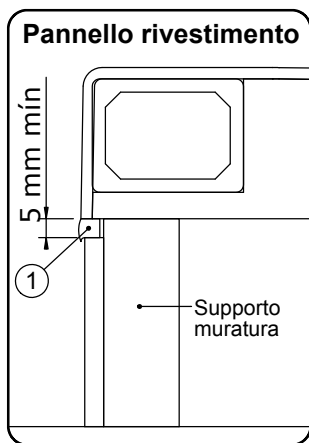
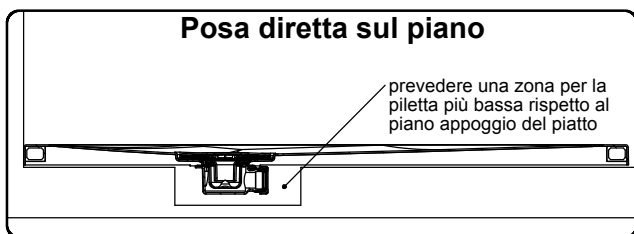

supporto di fondo

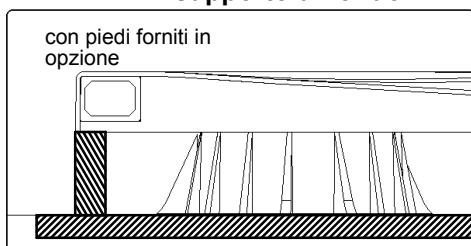

①



Durante tutta la durata dei lavori proteggere il piatto da eventuali abrasioni, colpi o rottura



Montaggio di una valvola di non ritorno è necessaria per un uso ottimale se vi è collegato un altro sanitario sullo stesso scarico

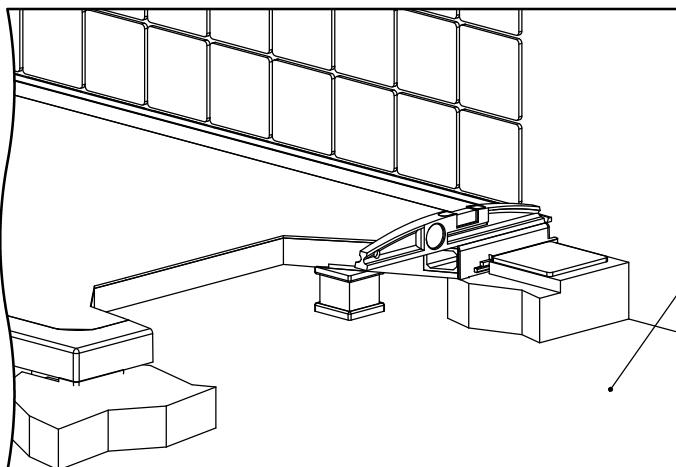

il suolo deve esser rigido e non umido

Posa diretta sul pavimento

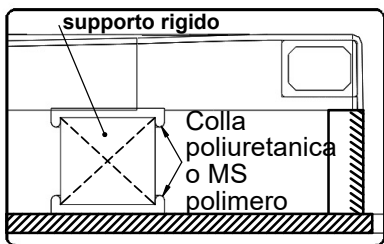

Incassato

5 mm mini

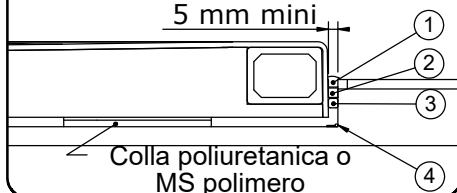

- MISE EN PLACE DES PLOTS DE COLLE POLYURETHANE OU MS POLYMERE
 - LADEN SIE DIE GRUND KLEBER POLYURETHAN ODER MS-POLYMERE
 - BRENG DE POLYURETAAN LIJM OF MS POLYMEERAAN OP DE JUISTE PLAATS
 - COLOCACIÓN DE PLACAS DE PEGAMENTO DE POLIURETANO O MS POLYMER
 - POSIZIONAMENTO PIASTRE DI COLLA POLIURETANO O MS POLIMERO
- Exemple receveur **100x80** ● voorbeeld met douchebak **100 x 80**
- Beispiel mit Duschwanne **100 x 80** ● ejemplo de plato de ducha **100 x 80**
- esempio di piatto doccia **100 x 80**

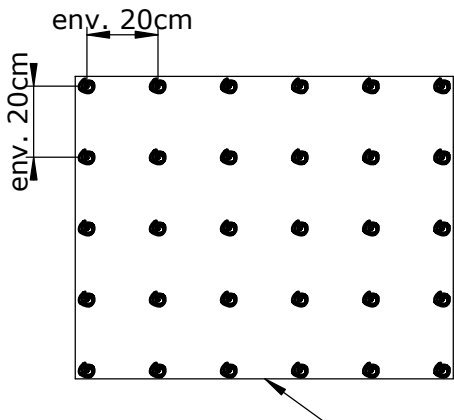

- Colle Polyuréthane ou MS Polymère ● Lijm polyurethaan of MS poltmeer
- Polyurethan-knebstoff oder MS-polymer ● Pegamento poliuretano o polimero
- Colla poliuretano o MS polimero

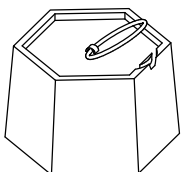
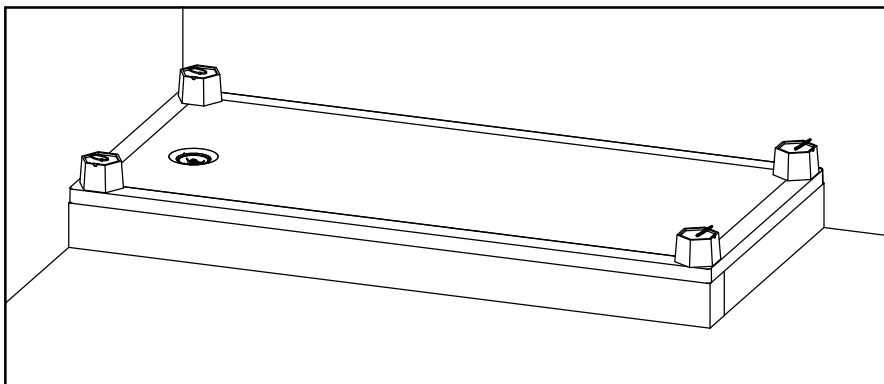

= 15Kg



24H

KINESURF MOGELIJKE INSTALLATIES VOOR DOUCHEBAKKEN

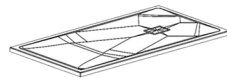

1. Geplaatst op stelpoten en afgewerkt met betegeling

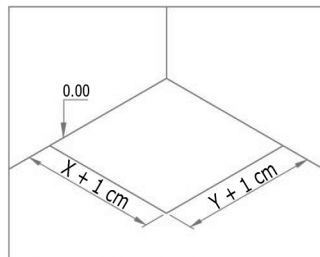
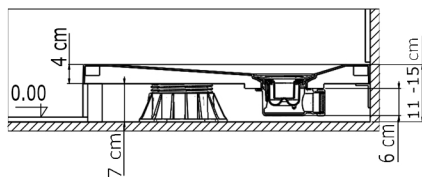
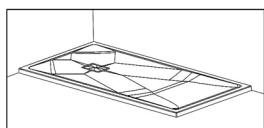

Vorbereitung van de montage

2. Geplaatst op tegelvloer

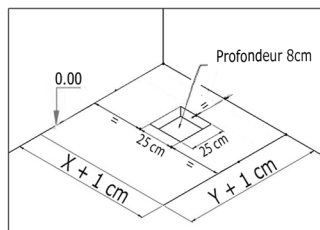
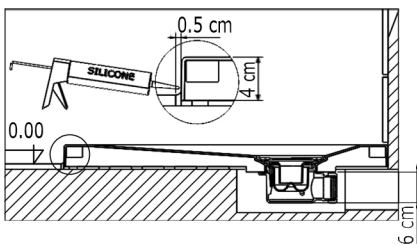
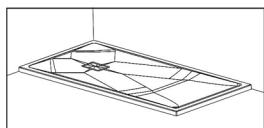

Vorbereitung van de montage

3. Ingebouwd en geplaatst op stelpoten

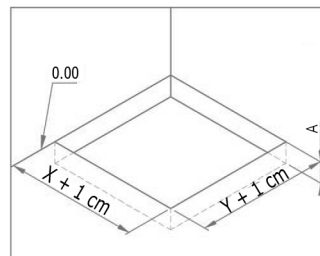
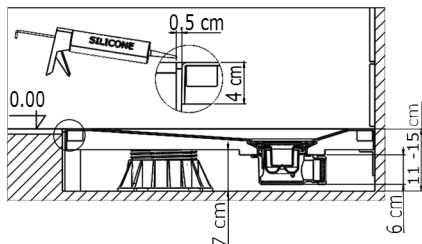
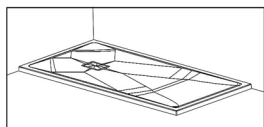

Vorbereitung van de montage

4. Ingebouwd en geplaatst zonder stelpoten

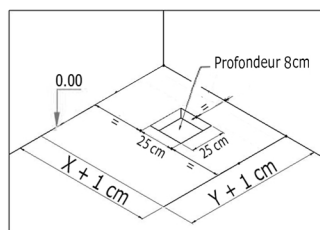
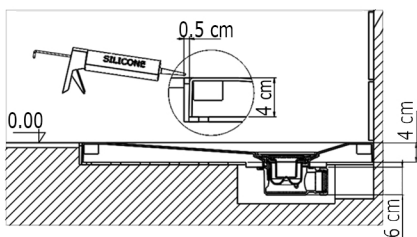
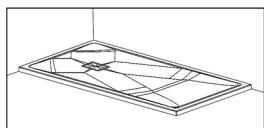

Vorbereitung van de montage

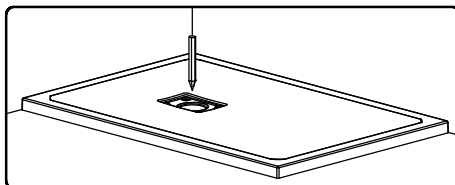

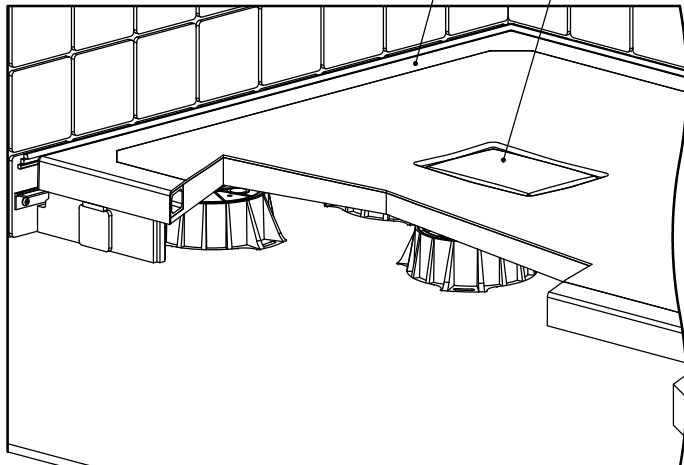
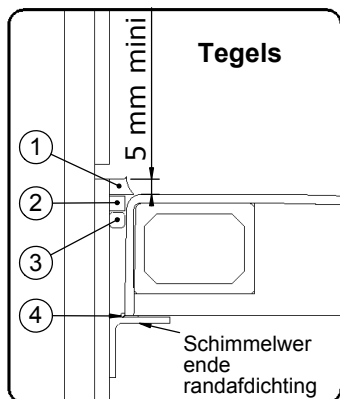

Markeer de positie van de afvoer en bepaal de plaats van de afvoer en de douchebak

- ① - Schimmelwerende siliconenkit met een lengte van minimaal 5mm
- ② - Siliconenkit voor een waterdichte afwerking, met schimmelwerende werking
- ③ - Steunelement van silicone pakking
- ④ - Siliconen ondersteuning

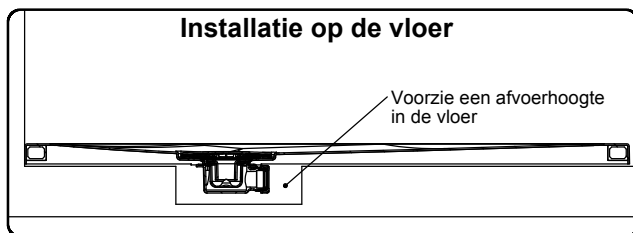
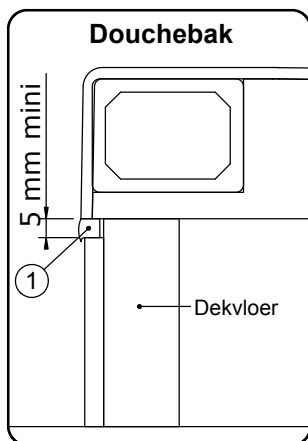

Breng een schimmelwerende afdichting aan, langs alle zijden van de douchebak.



Versterking van de ondergrond

Optioneel geleverd inclusief stelpoten

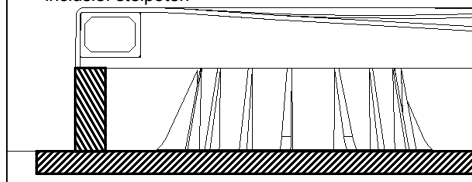



Bescherm de douchebak tijdens de werkzaamheden tegen brand, schokken, krassen etc.



Voor een optimaal gebruik is de montage van een terugslagklep noodzakelijk indien een ander sanitair toestel wordt aangesloten op dezelfde afvoer.

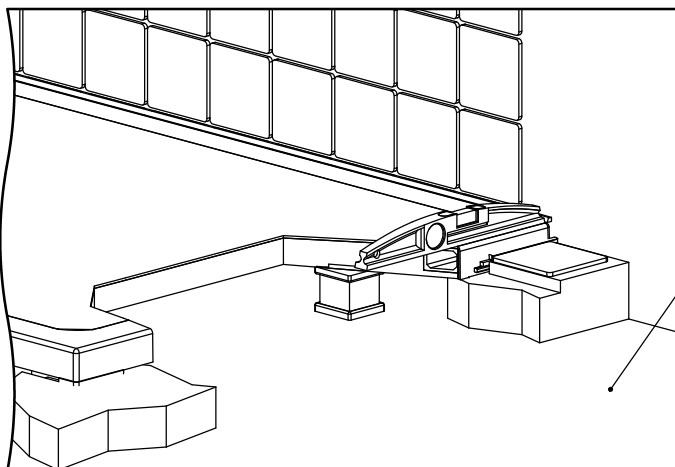

De ondergrond moet volkomen vlak en droog zijn

Direct op de grond

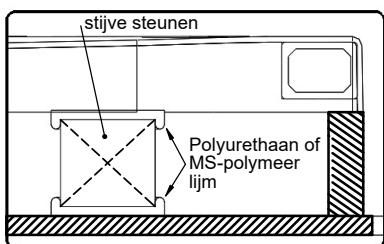
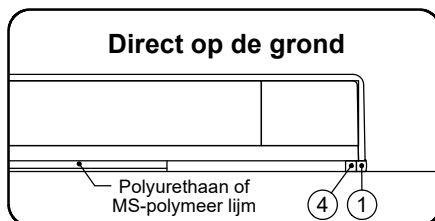

Installatie op de vloer

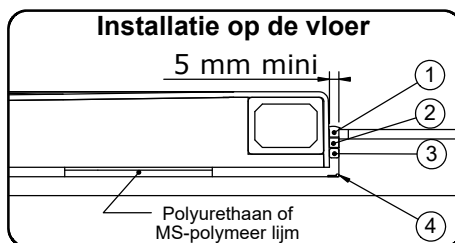

- MISE EN PLACE DES PLOTS DE COLLE POLYURETHANE OU MS POLYMERE
 - LADEN SIE DIE GRUND KLEBER POLYURETHAN ODER MS-POLYMERE
 - BRENG DE POLYURETAAN LIJM OF MS POLYMEERAAN OP DE JUISTE PLAATS
 - COLOCACIÓN DE PLACAS DE PEGAMENTO DE POLIURETANO O MS POLYMER
 - POSIZIONAMENTO PIASTRE DI COLLA POLIURETANO O MS POLIMERO
- Exemple receveur **100x80** ● voorbeeld met douchebak **100 x 80**
- Beispiel mit Duschwanne **100 x 80** ● ejemplo de plato de ducha **100 x 80**
- esempio di piatto doccia **100 x 80**

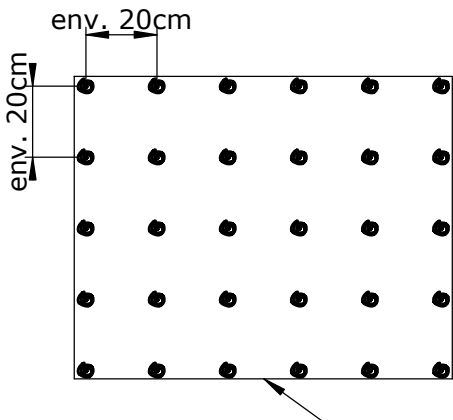

- Colle Polyuréthane ou MS Polymère ● Lijm polyurethaan of MS poltmeer
- Polyurethan-knebstoff oder MS-polymer ● Pegamento poliuretano o polimero
- Colla poliuretano o MS polimero

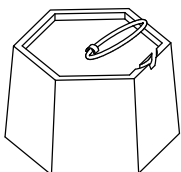
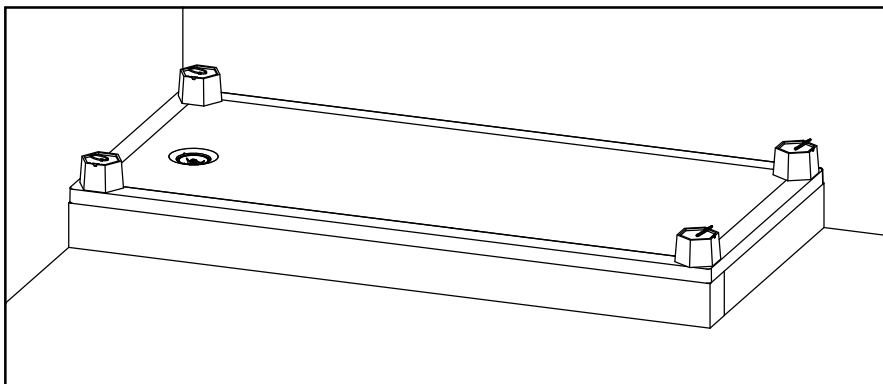

= 15Kg



24H

KINESURF MONTAGEMÖGLICHKEITEN FÜR

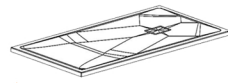

1. Montage auf einstellbarem Fliesensockel

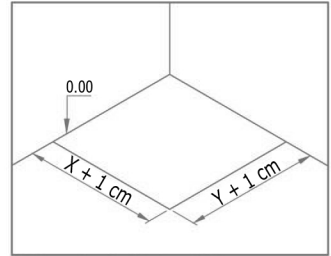
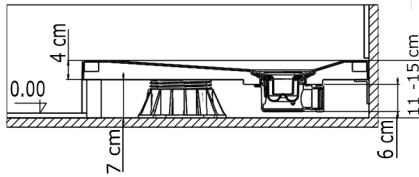
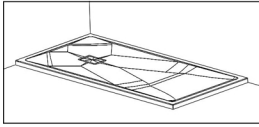

Vorbereitung der Montage

2. Auf Fliesenboden aufliegend

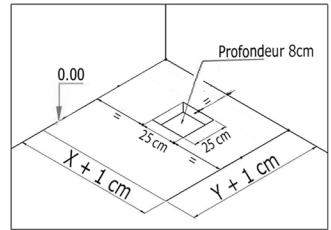
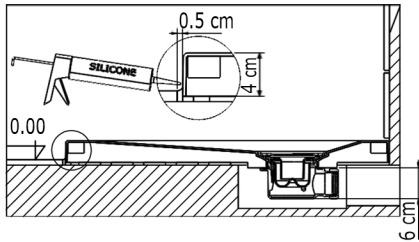
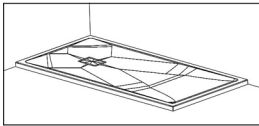

Vorbereitung der Montage

3. Eingebettet und mit einstellbarem Sockel

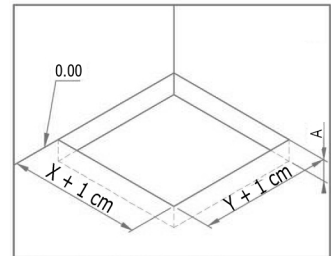
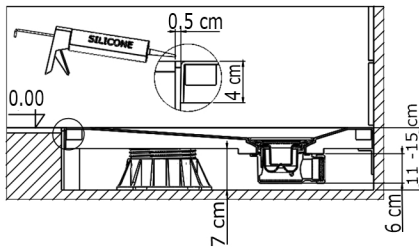
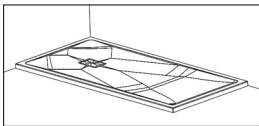

Vorbereitung der Montage

4. Eingebettet und ohne einstellbaren Sockel

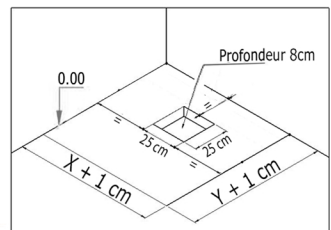
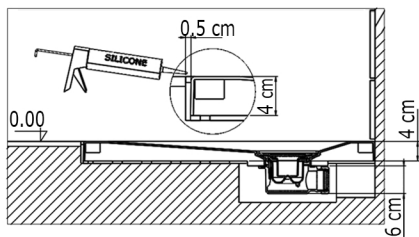
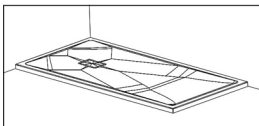

Vorbereitung der Montage

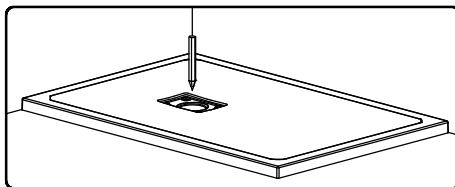
D

Die Position für den Ablauf anzeichnen und vormontieren

- ① - Pilzhemmendes Silikon mit einer Mindestbreite von 5mm
- ② - Weiches pilzhemmendes Dichtsilikon
- ③ - Stützelement der Silikondichtung
- ④ - Sanitärsilikon

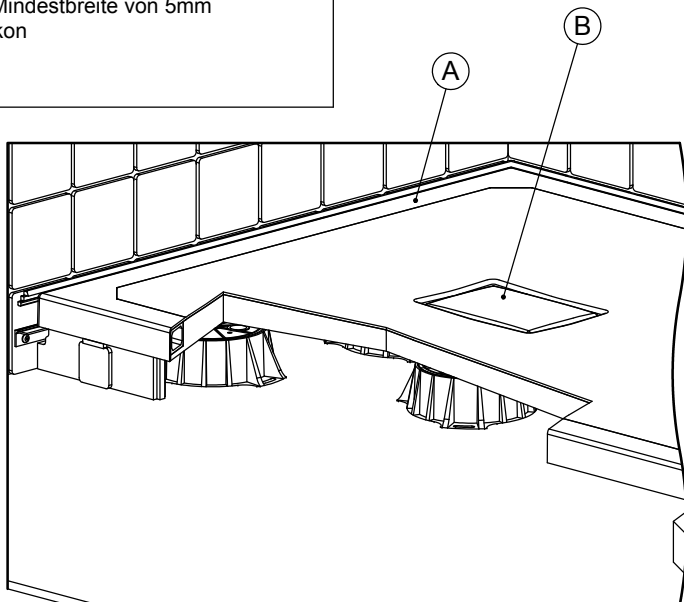
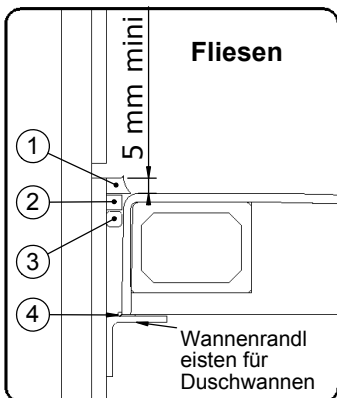

Es ist wichtig zu haben eine verrottungsfeste Unterstüztung auf alle Seiten des Empfängers.

Montage direkt am Boden oder bündige Einbettung

Für den Ablauf eine Aussparung unter dem Boden vorsehen, Mindesttiefe 70mm

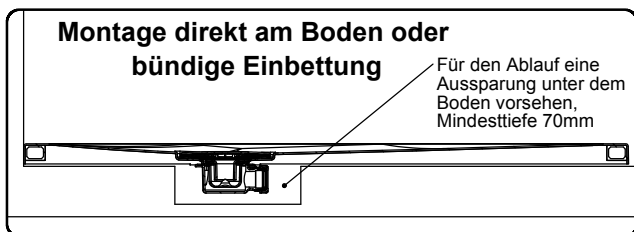

Außenverkleidung

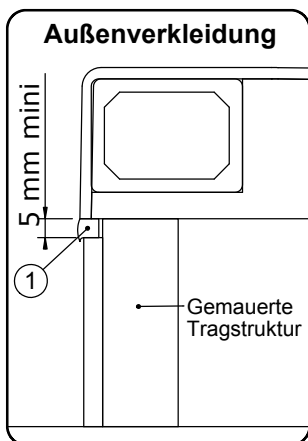

Rückwärtige Tragstruktur

Mit optional gelieferten Sockelfüßen

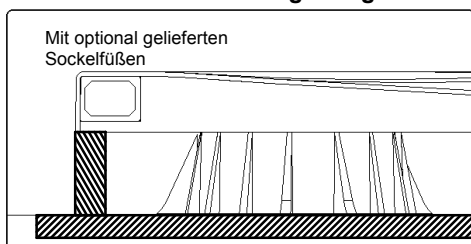



Während der gesamten Dauer der Arbeiten ist die Duschtasse vor allen möglichen Beschädigungen zu schützen



Montage eines Anti-Vakuum-Ventils ist notwendig für die Verwendung optimal, wenn ein anderes Sanitärgerät ist mit der gleichen Evakuierung verbunden.

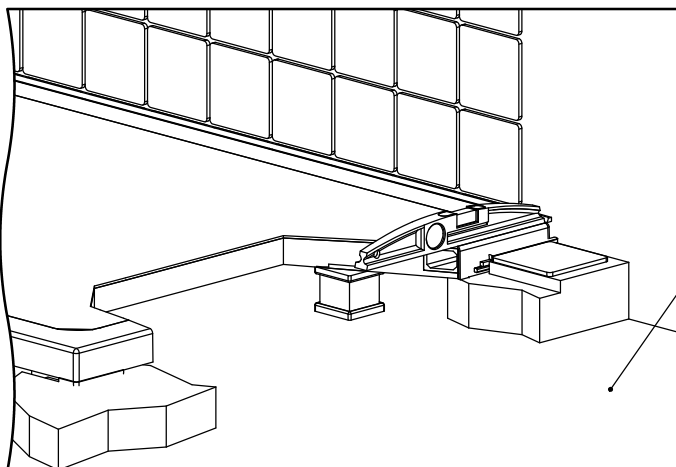

Ein fester und trockener Untergrund ist unabdingbar

Montage direkt am Boden

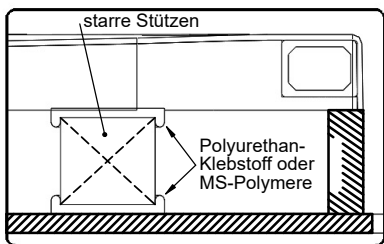
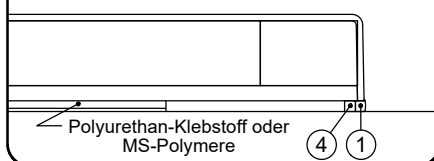

Encastrement bord à bord

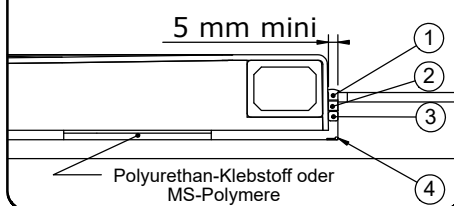

- MISE EN PLACE DES PLOTS DE COLLE POLYURETHANE OU MS POLYMERE
 - LADEN SIE DIE GRUND KLEBER POLYURETHAN ODER MS-POLYMERE
 - BRENG DE POLYURETAAN LIJM OF MS POLYMEERAAN OP DE JUISTE PLAATS
 - COLOCACIÓN DE PLACAS DE PEGAMENTO DE POLIURETANO O MS POLYMER
 - POSIZIONAMENTO PIASTRE DI COLLA POLIURETANO O MS POLIMERO
- Exemple receveur **100x80** ● voorbeeld met douchebak **100 x 80**
- Beispiel mit Duschwanne **100 x 80** ● ejemplo de plato de ducha **100 x 80**
- esempio di piatto doccia **100 x 80**

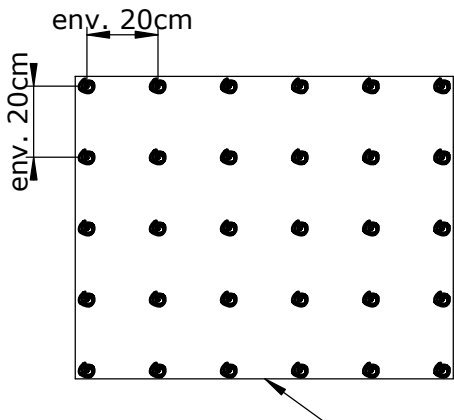

- Colle Polyuréthane ou MS Polymère ● Lijm polyurethaan of MS poltmeer
- Polyurethan-knebstoff oder MS-polymer ● Pegamento poliuretano o polimero
- Colla poliuretano o MS polimero

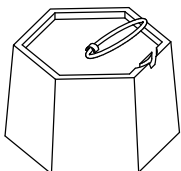
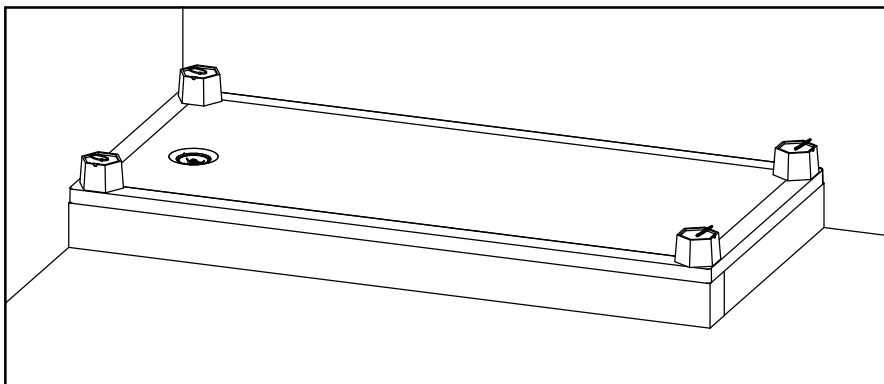

= 15Kg



24H

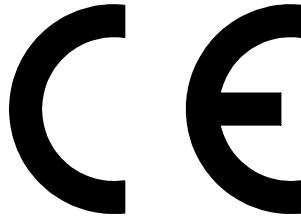

AQUAPRODUCTION, Site industriel,
F - 44680 Chaumes-en-Retz

18

EN 14527 - CL2

Aptitude au nettoyage : satisfaisant

Durabilité : satisfaisant



SERVICE APRÈS-VENTE AFTER-SALES SERVICE

FRANCE

+33 (0)2 40 21 29 45

UK

+44 (0)20 8842 0033

IRELAND

+353 04697 33102

DEUTSCHLAND

+49 (0) 6074 / 30928 0

ITALIA

+39 (0382) 6181

ÖSTEREICH

+43 1 710 60 70

SUISSE/SCHWEIZ

+41 (0)32 631 04 74

ESPAÑA

+34 93 544 60 76

NEDERLAND

+31 475 487 100

BELGIQUE/BELGIË

+31 475 487 100

РОССИЯ

+7 495 258-29-51

PORTUGAL

+351 219 112 785